

ARCHITECT AND FACILITY MANAGEMENT GUIDE

# Door Systems for Healthcare



Johns Hopkins Hospital  
Baltimore, MD



Cleveland Clinic Abu Dhabi  
United Arab Emirates



Lurie Children's Hospital  
Chicago, IL



*Premier Access That Lasts*

[www.hortondoors.com](http://www.hortondoors.com)

# Design Without Compromise

with the reliability and options you need  
from the pioneers of the automatic sliding door.



ORLEANS

EXIT

# Bringing Beauty and Performance to Healthcare



Dependability and aesthetics, a broad and customizable product range, and best local installation and service are reasons Horton doors are widely specified in healthcare facilities around the world.

Hospitals and medical facilities have specialized access needs that drive the toughest building codes. Horton continues to address those needs by developing first-to-market systems like self-closing smoke-rated ICU/CCU doors and the first airborne infection isolation room door (years before the COVID-19 pandemic).

All around the facility, Horton systems are creating Grand® revolving door entrances, hardworking interior and exterior doorways in swing, slide, folding and barn door solutions, and even drive-up convenience with pharmacy windows. Select from an almost unlimited number of custom configurations and colors to differentiate your design style and satisfy unique specifications.

Experience the innovative designs, legendary performance and durability of Horton doors in your next project.



**ARCHITECTS TOOLS**

<https://hortondoors.com/architects-corner>

# The Horton Difference

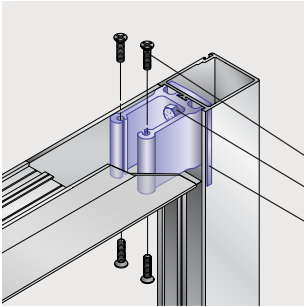

## EXCLUSIVE

### Anti-Warp Door Panel Construction

Commercial-grade heavy-duty rails with integral mortise-style corner block for structural integrity and longevity.

- Four #10-24 bolts secure corner block to horizontal rail
- Two #1/4-20 bolts secure corner block to vertical rail
- Concave steel back-up plate engineered as built-in self locking device for Grade 8 bolts

*Compare to mass-produced thru-bolt designs.*

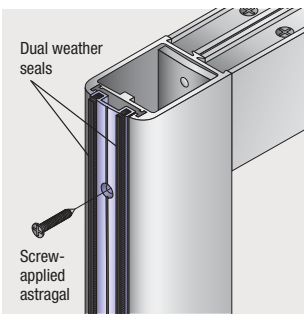

## EXCLUSIVE

### Tight Double Astragal Weather Seals

Horton's exclusive floating astragal creates a positive seal that stands up to the environment and high traffic. Horton's floating weather seals are permanently captured in the lead rail and screw-applied to the door panels.

*Compare to mass-produced adhesive-applied fixed seals.*

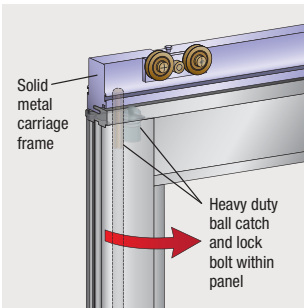

## EXCLUSIVE

### Self-Latching Swing Panel

Horton's standard self-latching mechanism brings the panel to the normal operating position without user intervention. Swing breakout panels are reinforced with a solid metal bar whose scissor-action provides support through full length of the panel.

*Compare to mass-produced, non-self-latching, thin wall, shorter-life alternatives.*



### Custom Finishes Enhance the Aesthetics of Your Design

Horton door systems may be specified with powder coat finishes in a wide range of custom colors including wood grain. Thermally cured for toughness, these earth-friendly PVDF coatings\* offer superior durability and color retention, even in the harshest environments. Liquid paint-clad finishes are also available.

\*VOC-free, consistent with your LEED objectives

Also available in brass alloy & stainless steel



### Proven Performance

Horton's electromechanical designs deliver years of trouble-free performance with units tested to 5 million cycles.



## We Make Your Visions Accessible.

Reliable, aesthetically pleasing access solutions from the most trusted name in commercial doors.



# Custom Solutions

- INTENSIVE/INTERMEDIATE/CRITICAL CARE UNIT SYSTEMS** **9**
- Profiler® ICU . . . . . 10
- Profiler® ICU XM . . . . . 10
- Profiler® Smoke Rated Telescoping ICU . . . . . 11
- Profiler® ICU Bi-Fold/Bi-Swing™ . . . . . 11
- PATIENT ROOM SYSTEMS** **12**
- Profiler® Sliding Patient Corridor Door Systems . . . . . 12
- Profiler® ICU SmokeSwing™ . . . . . 13
- Profiler® Barn Door . . . . . 13
- FlexBarn™ Barn Door . . . . . 13
- NEGATIVE, POSITIVE & COMBINATION PRESSURE ROOM SYSTEMS** **14**
- Airborne Infection Control . . . . . 14
- UltraClean® Atmospheric I . . . . . 15
- UltraClean® Atmospheric II . . . . . 15
- UltraClean® Sterile . . . . . 16
- AUTOMATIC ENTRANCE SYSTEMS: SLIDING** **17**
- Profiler® . . . . . 18
- ProSlide® . . . . . 18
- ProSlide® Telescoping . . . . . 19
- Elegant® . . . . . 19
- AUTOMATIC ENTRANCE SYSTEMS: SWINGING & FOLDING** **20**
- HD-Swing® . . . . . 21
- EasyAccess® . . . . . 21
- HD-Swing® LE . . . . . 22
- Other Swing Door Packages . . . . . 22
- Specialty Operators . . . . . 22
- FoldingAccess® . . . . . 23
- AUTOMATIC ENTRANCE SYSTEMS: REVOLVING & SECURITY** **24**
- Grand® . . . . . 25
- MiniGrand® . . . . . 25
- ControlFlow® . . . . . 27
- SPECIAL PURPOSE DOORS & WINDOWS** **28**
- Lead-Lined X-Ray Room Sliding Doors . . . . . 28
- Transaction Windows . . . . . 28
- ACTIVATION AND SENSORS** **29**
- DOOR SELECTION TOOLS** **30**
- INSTALLATION AND SERVICE** **31**

## SPECIAL FEATURES

				
Self Closing	Breakout	Automatic	Manual	Trackless
				
ADA	Smoke Rated	Security	Energy Efficient	

Complement your sophisticated design and creativity with Horton's unparalleled offering.

- Main Entrances
- Emergency
- Administration
- Intensive Care
- Newborn Intensive Care
- Pediatric Care
- Bariatric Care
- Intermediate Care
- Cardiac Care
- Patient Care
- Surgical Rooms
- Radiology
- Nursery Units
- Corridors
- Pharmacy

### Intensive/Intermediate/Critical Care Door Systems

Patients are always in full view through the sliding glass door. The full breakaway feature allows for all panels to swing out of the way, providing a large opening for swift removal of patients or equipment.



### Toilet Room and Interior Room Systems

Easy-to-open, space-saving and attractive barn doors are an excellent choice for patient bathrooms, offices and meeting rooms.

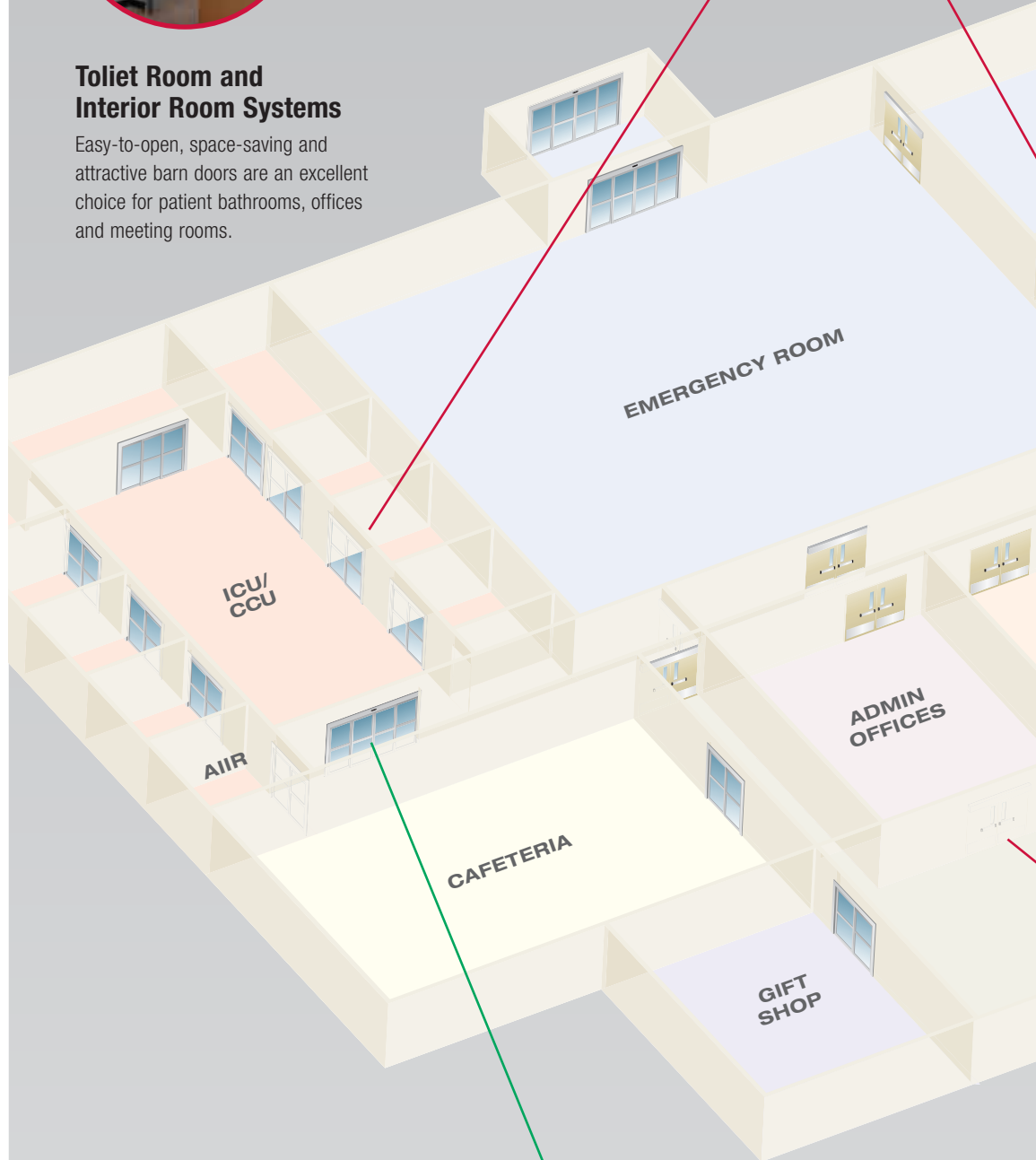

### Negative, Positive and Combination Pressure Room Systems

Available in automatic and mechanical self-closing, these systems provide the option for an architect to address multiple areas where Airborne Infection Isolation Room (AIIR) doors may be needed.



To view our healthcare product video, use your smartphone to access the QR code.

## Revolving Door Systems

Turn an ordinary entrance into an energy-efficient vestibule system. This large diameter automatic revolving entrance easily accommodates wheelchairs and gurneys.



## Patient Room Systems

With the greatest width and clear opening available, these door systems are built with beauty and functionality in mind.

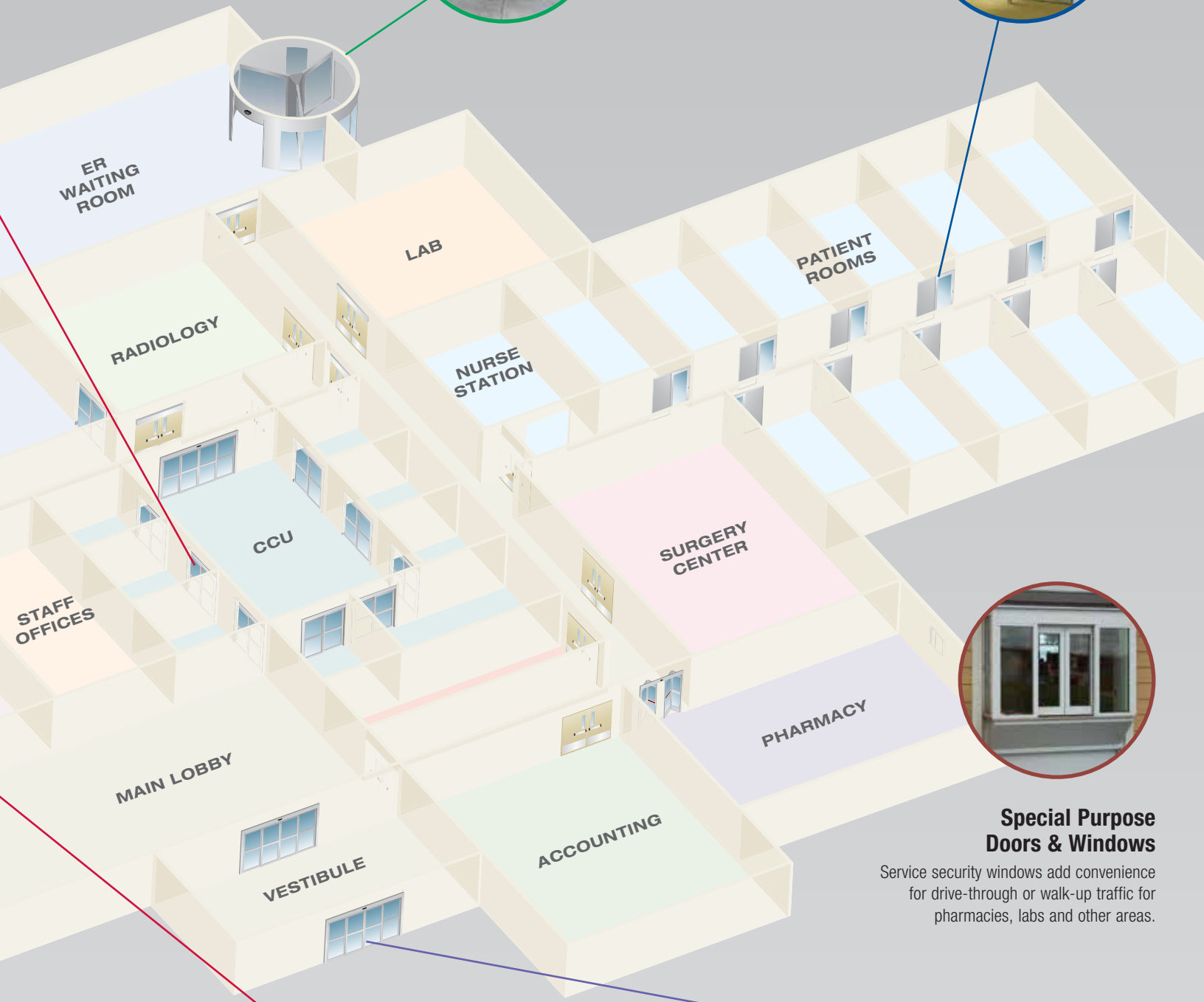

## Special Purpose Doors & Windows

Service security windows add convenience for drive-through or walk-up traffic for pharmacies, labs and other areas.



## Swing Door Systems

Designed for high traffic entrances providing convenience and reliability. The variety of designs and applications will satisfy any architectural requirement.



## Sliding Door Systems

Our broad offering of sliding doors gives you a wide range of choices to meet your exacting requirements for size, color, finish and security.



# Healthcare Door Comparison

Models	MARKETS										FEATURES									
	Intensive/Intermediate Patient Room Systems	Negative, Positive & Combination X-Ray	Automatic Entrance Systems—Pressure Room Systems	Automatic Entrance Systems—Sliding	Automatic Entrance Systems—Swinging & Folding	Special Purpose	General Traffic	High Traffic	Trained Traffic	ADA Compliant	EPD	ECO/U-value	Smoke Rated	Air Leakage Test	Infection Control	Trackless	All Glass	ISO 3 (ISO 14644)	ISO 5 (ISO 14644)	
<b>MANUAL</b>																				
Profiler® ICU	•	•							•			•			•			•		
Profiler® Self-Closing ICU XM	•	•							•			•			•			•		
Profiler® Self-Closing, Smoke-Rated ICU	•	•							•			•			•			•		
Profiler® ICU/CCU Bi-Fold/Bi-Swing™	•	•							•		•									
Profiler® Sliding Patient Doors		•							•		•				•			•		
Profiler®-ICU SmokeSwing™		•							•		•		•							
Profiler® Barn Door		•							•		•		•				•			
FlexBarn™ Barn Door		•							•		•		•				•			
Airborne Infection Isolation System: Self-Closing IDS			•							•				•	•					
X-Ray Sliding Doors				•						•										
Transaction Windows									•		•									
<b>AUTOMATIC</b>																				
Airborne Infection Isolation System: 2000 IDS			•	•						•				•	•					
UltraClean® Atmospheric I										•	•						•			
UltraClean® Atmospheric II					•					•	•								•	
Profiler®					•				•		•		•	•	•	•				
ProSlide® 2003					•					•			•							
ProSlide® 2021					•					•		•	•							
ProSlide® Telescoping					•					•		•	•	•						
Elegant®					•					•						•	•			
HD-Swing®						•				•										
HD-Swing® LE						•				•										
EasyAccess®						•				•										
Custom Swing Door Packages						•				•										
Specialty Operators						•				•										
Folding Access®						•				•										
Grand®							•				•									
MiniGrand®							•				•									
ControlFlow®							•				•									



# Intensive/Intermediate/Critical Care (ICU/IMU/CCU) Systems



## Architectural Highlights

- Widths starting at 7 feet
- 1, 2, 3, 4 or 6 panel design
- Single or bi-parting
- Folding or telescoping applications
- Narrow, medium and wide stiles
- Available with choice of aluminum, paint or clad finishes
- Rugged breakaway system with full-width solid torsion bar assembly provides superior support in the breakaway position. The only UL listed system in the industry.
- ISO cleanroom rated

## Applications

- ICU/IMU/CCU
- Patient rooms
- Administration

## Header Operator Types

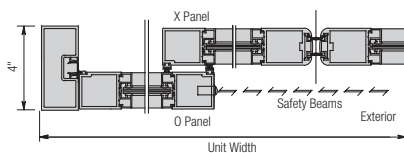

**Type 010** (No swing capability)  
Doors slide to interior of fixed sidelites.

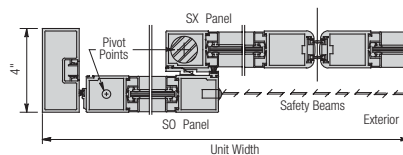

**Type 310** (All panels swing out)  
Largest breakout area for moving wide objects.  
Doors slide to the interior of fixed sidelites.

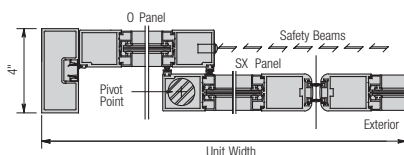

**Type 110** (Moving panels)  
Doors slide to the exterior of fixed sidelites.

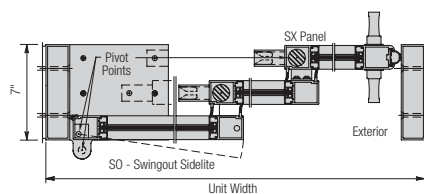

**Type 310T** (Telescoping)  
Two sliding door panels slide to the interior.



## Profiler® ICU

Smoke-Rated: ISO 3

This multi-function system allows the architect greater flexibility in room design. Systems come with a choice of header and threshold configurations either smoke or non-smoke rated.



### Architect's Options

- 1-, 2-, 3-, 4- or 6-panel configuration
- Trackless for unobstructed mobility and superior hygiene
- Self-closing mechanism available
- Privacy-glass available
- ISO 3 cleanroom options available
- UL1784 smoke-rated options available



Allows clear monitoring of the room and full breakaway to move patients.



Thin rails allow for greater patient visibility.

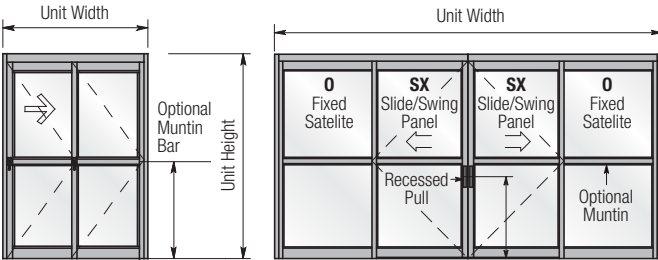

Shown: SX-SO (SO-SX Opposite)

**Type 310**

Shown: SO-SX-SX-SO

**Type 310**



## Profiler® ICU XM

Smoke-Rated: ISO 3

This maximum clear opening system has an adjustable, concealed-spring closing mechanism.



### Architect's Options

- Magnetic latch or positive latch
- Electromagnet closes door when the fire alarm is triggered
- Self-closing mechanism available
- ISO 3 cleanroom options available
- UL1784 smoke-rated or nonsmoke-rated
- Available in trackless configurations



Self-closing with adjustable hydraulic damper for smooth closing.



Manual opening with hold-open feature.

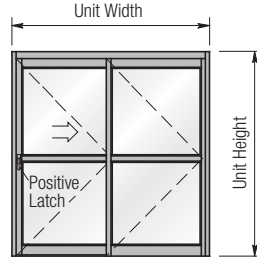

Shown: SX-SO

**Type 310, Single**

### Selection Guide

Model	Type	Unit Width	Max. Clear Opening	Type 110 Breakout Opening	Breakout Opening Type 310
<b>Profiler® ICU</b>	Single	7' to 9' (2134-2743)	3' to 4' (914-1219)	3' 3/2" to 4' 3/2" (1003-1308)	6' 3" to 8' 3" (1905-2515)
	Bi-parting	8' to 16' (2134-3658)	3' to 7' (914-2133)	3' 7" to 7' 7" (1092-2311)	6' 9/2" to 14' 9/2" (2070-4508)
	Telescoping	7' to 12' (2134-3658)	3' 9" to 7' 1" (1143-2159)	—	6' 1" to 11' 1" (1854-3378)
<b>Profiler® ICU XM</b>	Single	7' to 9' (2134-2743)	3' to 4' (914-1219)	3' 3/2" to 4' 3/2" (1003-1308)	6' 3" to 8' 3" (1905-2515)



## Profiler® Telescoping ICU

### Large Clear Opening System

Available with a UL1784 smoke-rated label with up to 80 1/4" of clear opening width, this telescoping system allows for easy transfer of patients or medical equipment without the need to break away the doors. Offered in widths ranging from 7' to 12' in single slide configurations.

- Greater opening width than single slide door systems
- Track or trackless configurations
- Low profile header for superior aesthetics
- Exceeds the air leakage requirements of NFPA 105
- Smoke- or non-smoke rated



Up to 80 1/4" of clear opening width.



Both moving panels slide smoothly open with one-hand operation and close with assurance of positive latching.

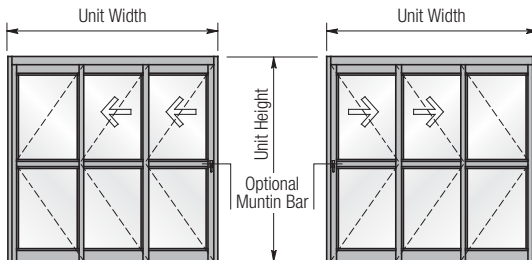

Shown: SO-SX-SX

Shown: SX-SX-SO

**Type 310T**



## Profiler® ICU Bi-Fold/Bi-Swing™

### Multi-Access 2-in-1 System

Versatile access with a swing door for normal 2-way traffic and an adjacent folding door dramatically increases the opening up to 6' 8".

- Breakout openings up to 83"
- Provides multiple options of use



Bi-Fold door creates additional clearance for patient and equipment moves.



Bi-Swing manual door opens conveniently in both directions for normal traffic.

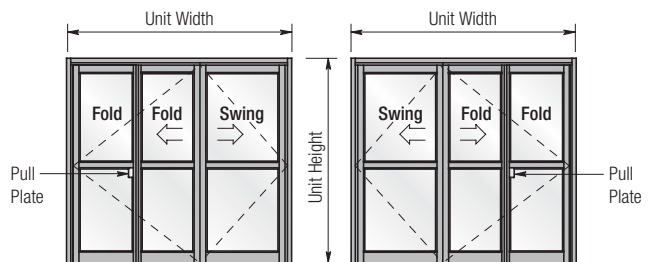

### Selection Guide

Model	Type	Unit Width	Max. Clear Opening	Type 310 Breakout Opening
<b>Profiler® Smoke-Rated Telescoping ICU/CCU</b>	Single Slide	7' to 12' (2133–3658)	3' 4/4" to 6' 8/4" (1022–2038)	6' 1" to 11' 1" (1854–3378)
<b>Profiler® ICU/CCU Bi-Fold/Bi-Swing™</b>	Swing/Folding	6' to 8' (1829–2438)	4' 8" to 6' 8" (1422–2032)	4' 11" to 6' 11" (1499–2108)

# Patient Room Systems



## Profler® Sliding Patient Corridor Door System

Smoke-Rated Corridor Door: ISO 3

This surface mounted system allows for large clear openings to produce greater flexibility to optimize patient room design.



- Choice of horizontal bars
- Available in narrow, medium and wide stile configurations
- Positive latch available
- UL1784 smoke-rated option available
- ISO 3 cleanroom options available



Less than 5 lbs of force required to open and close.



Greatest clear opening of any non-breakout smoke-rated door on the market.

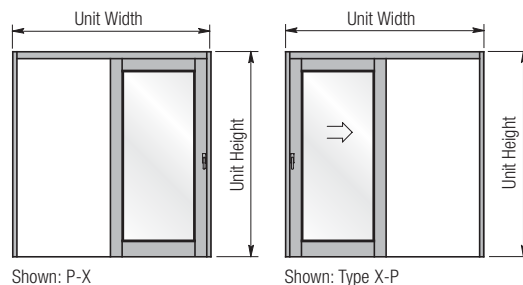

Shown: P-X

Shown: Type X-P

*"We are glad to have collaborated with Horton Automatics on the Southwest Washington Medical Center project. Not only did Horton implement an aesthetic and superior design that helped us differentiate our offering, but also met stringent time and quality requirements."*

Leigh Sutphin  
Principal NBBJ – Seattle

## Architectural Highlights

- Smoke and non-smoke rated systems
- Sliding and swinging configurations
- Track or trackless (most systems)
- Custom widths
- Optimized header size for superior aesthetics

### Selection Guide

Model	Type	Unit Width	Max. Clear Opening
<b>Profler® Sliding Patient Corridor Door System</b>	P-X or X-P Single	7' 6" to 11' 3/8" (2286–3432)	3' 1/4" to 5' 11/16" (921–1492)



## Profiler® ICU SmokeSwing™

### Single, Unequal & Equal Pair Swing Doors

Meeting UL1784 smoke-rating, these systems are ideal for smaller rooms without sacrificing clear opening space. They allow up to 91" of opening area for easy movement of patients and hospital equipment.



- Choice of privacy glass for patient rooms, hygiene and beauty
- Trackless design for unobstructed traffic management
- Mini-blind glass & fire-rated panels also available for single slide door systems
- Opaque glass is available for privacy at the flick of a switch



Partial open for light control in evening hours.



Full close for maximum privacy and light control when needed.

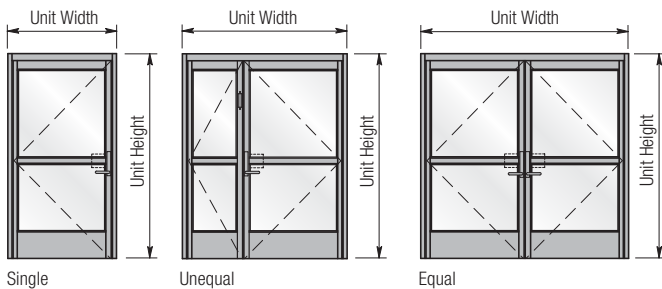

## Profiler® Barn Door

### Manual Glass Sliding Door

This stylish system is UL1784 smoke-rated, setting the standard for healthcare and office applications.

- Trackless design for unobstructed traffic management
- Spring closing or power open/close
- Manual operation – low open/close force of 5 lbs or less
- 1-, 2-, 3- and 4-panel configurations
- Available in smoke-rated or non-smoke rated

#### Applications

- Patient rooms
- Exam rooms
- Patient toilet room
- Offices
- Laboratories
- Equipment rooms

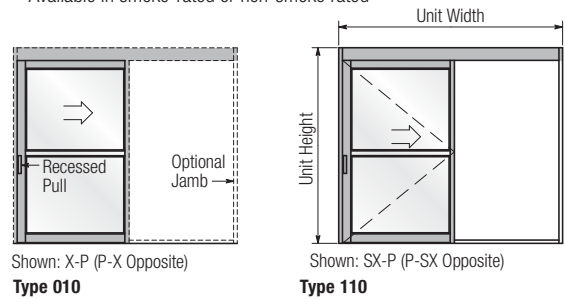

Shown: X-P (P-X Opposite)

**Type 010**

Shown: SX-P (P-SX Opposite)

**Type 110**

## FlexBarn™ Barn Door

### Surface-Applied Multi-Use

Manual Sliding Door System  
Ideal for everyday use, the attractive FlexBarn™ features ADA-compliant hardware, trackless design and a soft close/soft open dampening system for seamless operation and unobstructed access.

- Available in antimicrobial aluminum door & frame system
- Available in wood species solid core lumber and plastic laminate and a variety of glass options
- Broad range of glazing selections
- Unlimited finish options
- Available in smoke-rated UL 1784

#### Selection Guide

Model	Type	Unit Width	Max. Clear Opening
Profiler® ICU SmokeSwing™	Single	3' 3/8" to 4' 3/8" (1003–1308)	2' 11/4" to 3' 11/4" (895–1200)
	Unequal	5' 3/8" to 6' 3/8" (1613–1918)	4' 7" to 5' 7" (1397–1702)
	Equal	6' 3/8" to 8' 3/8" (1918–2527)	5' 7" to 7' 7" (1702–2311)
Profiler® Barn Door	Single	7' to 9' (2134–2743)	2' 10 1/2" to 3' 10 1/2" (876–1181)
	Bi-Parting	8' to 16' (2438–4877)	2' 10 1/2" to 6' 10 1/2" (876–2096)
Profiler® Smoke-Rated Barn Door	Single	7' to 9' (2134–2743)	2' 10 1/2" to 3' 10 1/2" (876–1181)
FlexBarn™	Single	6' 9" to 9' 5" (2057–2870)	3' to 4' 4" (914–1321)
	Bi-Parting	9' 4" to 15' 4" (2845–4674)	4' to 7' (1219–2134)

# Negative, Positive & Combination Pressure Room Systems



## Airborne Infection Control Isolation Room System

The automatic 2000-IDS and mechanical self-closing IDS isolation room door systems include perimeter seals and self-closing devices. These systems are easy to clean and reduce the risk of nosocomial infections. Available in electromechanical or mechanical self-closing.

### Additional Features

- Trackless
- Can be used as a patient room system
- Clear opening widths up to 48"
- Available in telescoping configuration



Automatic isolation room door with touchless system to ensure doors are only opened when activated.



Mechanical self-closing system that smoothly closes and positive latches after each opening.

These door systems address the critical need for negative, positive and combination pressure isolation rooms. The 2000-IDS is an automatic door system that opens with your choice of touchless sensors or push plates. The alternative mechanical self-closing system requires no power. Available in partial or full breakout.

## Architectural Highlights

- Self-closing
- Offers up to 48" of clear opening width
- Available in full breakout telescoping configurations

## Applications

- Pediatric Care (PICU)
- Intensive Care
- Intermediate Care
- Critical Care
- Newborn Intensive Care (NICU)
- Nursery Unit
- Biohazard Rooms

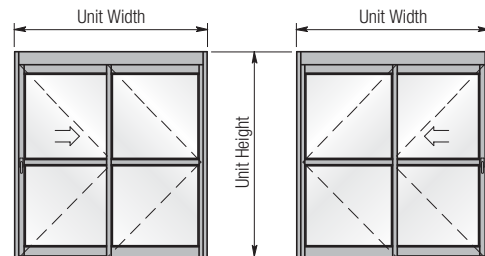

Shown: SX-SO

Shown: SO-SX

**Type 310**

Selection Guide						
Model	Type	Activation	Unit Width	Max. Clear Opening	Type 310 Breakout Opening	
<b>Airborne Infection Control</b>	2000-IDS	Automatic	7' to 9' (2134-2743)	3' to 4' (914-1219)	6' 3" to 8' 3" (1905-2515)	
	Self Closing IDS	Manual	7' to 9' (2134-2743)	3' to 4' (914-1219)	6' 3" to 8' 3" (1905-2515)	



## UltraClean® Atmospheric I

Series 2021 and 2000B ISO 3

Designed to meet ISO 14644 Class 3 cleanroom applications. Surface applied or perimeter mounted for a seamless appearance. Pair the UltraClean with our ProSlide® automatic sliding door, which is available in ECO/U-value for matching sightlines.

### Applications

- Cleanroom air showers
- Sterile environments
- Pharmaceutical and healthcare labs
- Chip manufacturing/processing

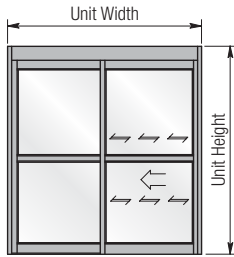

Type 310

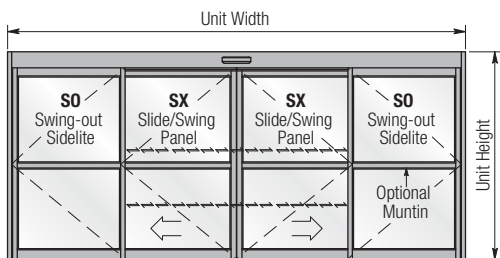

Type 310

### ISO 14644-1 Cleanroom Standards

ISO classes specify the maximum concentration limits of a range of particle sizes collected from the cleanroom's air. Refer to table to determine which door fits your specific needs.

Particles/m <sup>3</sup> Particle Size	ISO 3	ISO 5	ISO 9
0.1 µm	1,000	100,000	-
0.2 µm	237	23,700	-
0.3 µm	102	10,200	-
0.5 µm	35	3,520	35,200,000
1.0 µm	8	832	8,320,000
5.0 µm	-	29	293,000

1 µm = 1 millionth of a meter

## UltraClean® Atmospheric II

Series 2021 and 2000B ISO 5

### Atmospheric Sliding Doors

Designed and tested to meet ISO 14644 Class 5 cleanroom applications, these trackless doors are constructed and rigorously tested with Horton Automatics Series 2000B header and/or Series 2021 header. Available in single slide or bi-parting configurations with partial or full breakout. Surface applied or perimeter mounted.

- Available in single slide or bi-parting configurations
- Partial or full breakout

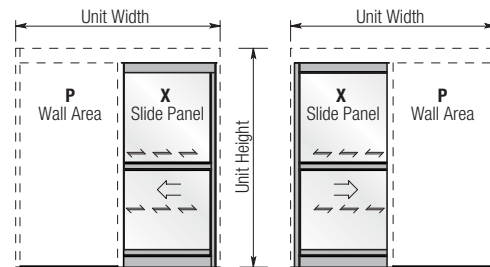

Shown: P-X

Shown: X-P

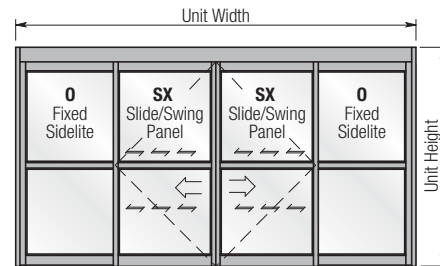

Shown: O-SX-SX-O

### Selection Guide

Model	Type	Unit Width	Max. Opening	Breakout Opening
UltraClean® Atmospheric I	Type 110	8' to 16' (2438-4877)	3' to 7' (914-2134)	3' 7" to 7' 7" (1092-2311)
	Type 310	8' to 16' (2438-4877)	3' to 7' (914-2134)	6' 9/2" to 14' 9/2" (2020-4509)
UltraClean® Atmospheric II	Single Slide	7' to 9' (2134-2743)	3' to 4' (914-1219)	-
	Bi-parting Slide	8' to 16' (2438-4877)	3' to 7' (914-2134)	-

# Pressure Room Systems



## UltraClean® Sterile Cleanroom Sliding Door Solutions

This automatic stainless steel sliding door system is ideal for very low particulate applications such as food preparation and pharmaceutical facilities and withstands frequent washdowns.



### Available in

- Single or bi-parting configurations
- None or partial breakout
- Surface or perimeter mounted
- Optional push plate or touchless activation

## Project Spotlight



### Lancaster General Emergency Department

*“There was a delay in the summer due to material procurement that could have been a major blow to the project opening date. Horton’s team, in combination with Susquehanna Door Service’s team, did a good job of recovering from the material procurement issue. They mobilized quickly and communicated throughout the entire process to ultimately get the materials we needed installed prior to the opening date. Every project has issues, but it’s how a vendor handles them that gives you confidence that you chose the right vendor. And I’m confident that we did.”*

Scott McDowel, Project Manager  
Zephyr Aluminum

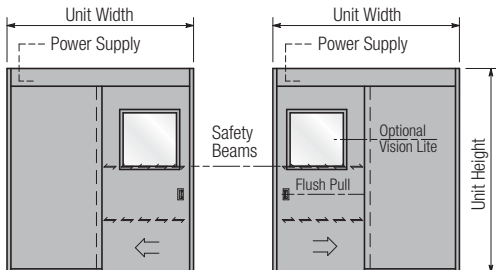

Shown O-X (X-O Opposite)

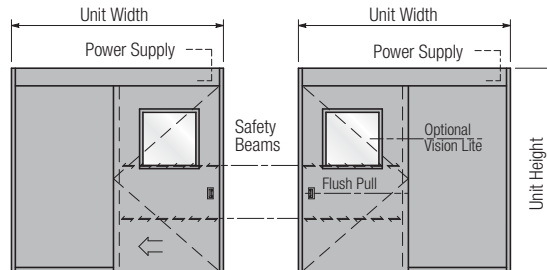

Shown O-SX- (SX-O Opposite)

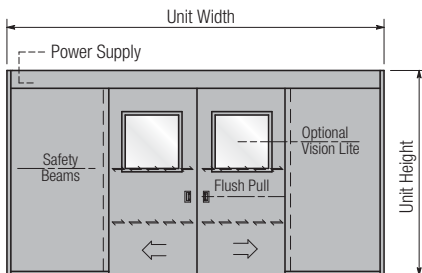

Shown O-X-X-0

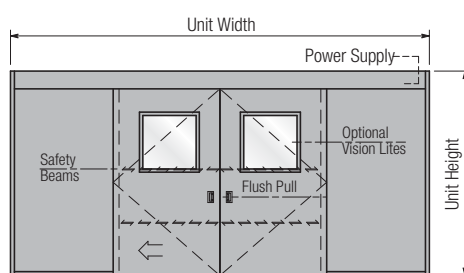

Shown O-SX-SX-0

### Selection Guide

Model	Type	Breakout	Unit Width	Max. Slide Opening	Breakout Opening
<b>UltraClean® Sterile</b>	Single	None	7' to 9'	3' to 4'	–
	Single	Partial	7' to 9'	3' to 4'	3' 3/2" to 4' 3/2"
	Bi-part	None	8' to 16'	3' to 4'	–
	Bi-part	Partial	8' to 16'	3' to 7'	3' 7" to 7' 7"



# Automatic Entrance Systems – Sliding



*"Horton's leading-edge products allow Automatic Door Enterprises a great deal of latitude in providing custom solutions to complex projects such as Paoli and Lankenau Hospitals."*

John Kwartnik  
Automatic Door Enterprises – Philadelphia

## Ultimate Dependability

Horton offers an industry-leading range of sliding entrance systems, all designed for maximum reliability and performance.



Positive latching handles with modified door nosings, bottom rails and interlock seals.

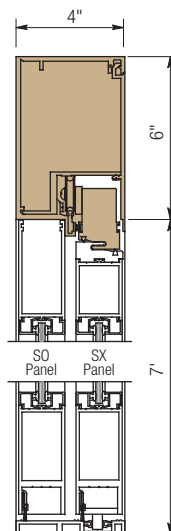

### Series 2000B

#### Elite Belt Drive System

- Panels up to 250 lbs
- Compact design for superior aesthetics
- Supplied with Profiler® and Profiler® Storm systems
- Flush to jambs header
- Durable 4" x 6" header



For additional information on our heavy duty and hurricane product lines, please use your smart phone and click here or go to [www.hortondoors.com](http://www.hortondoors.com)



## Profiler® Series 2000 General Traffic: Sleek Header

Available in our widest range of configurations, this door system is often selected for its visual appeal. Yet the real advantage is the system's dependability, with fewer parts to wear out and easy adjustments. Pair with the Profiler ICU for a seamless appearance.

- Available in**
- ICU packages
  - Isolation Door System (IDS) configurations
  - ISO 3 & 5 cleanroom configurations
  - Hurricane-rated packages

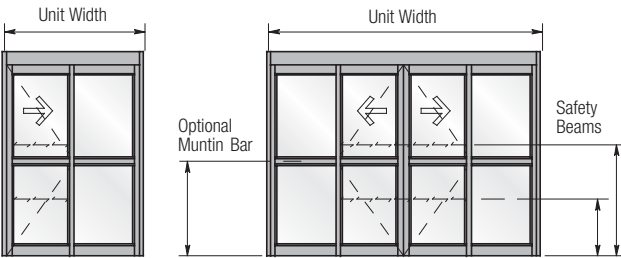

Shown: SX-0  
**Type 110**

Shown: 0-SX-SX-0

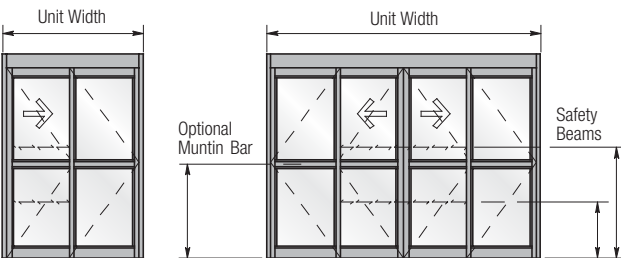

Shown: SX-SO  
**Type 310**

Shown: SO-SX-SX-SO



## ProSlide® Series 2021 and 2003 High Traffic/ ISO 3 - ISO 9 Specifiable

This heavy-duty system is engineered for long life and quiet operation in high traffic settings, can be specified as ISO 3 – ISO 9 cleanroom compliant and is available in an ECO/U-Factor option for energy efficiency and LEED certification. Environmental Product Declaration certified.

- Available in**
- None, partial & full breakout
  - U-factor
  - Single & bi-parting configurations

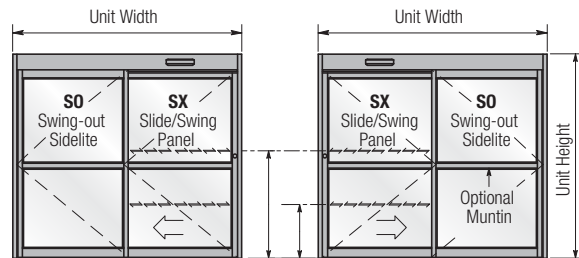

Shown: SO-SX  
**Type 310**

Shown: SX-SO

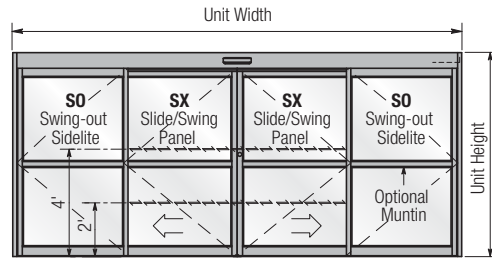

Shown: SO-SX-SX-SO  
**Type 310**

### Selection Guide

Model	Type	Unit Width	Max. Clear Opening	Type 110 Breakout Opening	Type 310 Breakout Opening
<b>Profiler® &amp; ProSlide® Series 2003</b>	Single	7' to 9' (2134–2743)	3' to 4' (914–1219)	3' 3½" to 4' 3½" (1003–1308)	6' 3" to 8' 3" (1905–2515)
	Bi-part	8' to 16' (2438–4877)	3' to 7' (914–2134)	3' 7" to 7' 7" (1092–2311)	6' 9½" to 14' 9½" (2070–4509)
<b>ProSlide® Series 2021</b>	Single	7' to 9' (2134–2743)	2' 11¼" to 3' 11¼" (908–1213)	3' 3¼" to 4' 3¼" (997–1302)	6' 4" to 8' 4" (1930–2540)
	Bi-part	8' to 16' (2438–4877)	3' 1½" to 7' 1½" (953–2172)	3' 8½" to 7' 8½" (1130–2350)	6' 11½" to 14' 11½" (2121–4559)



## ProSlide® Telescoping Series 2003T For Narrow Passageways

This system effectively increasing the opening width more than 35 percent. Available in single or bi-parting configurations.

- Ideal for emergency room vestibules
- Available with muntin bars

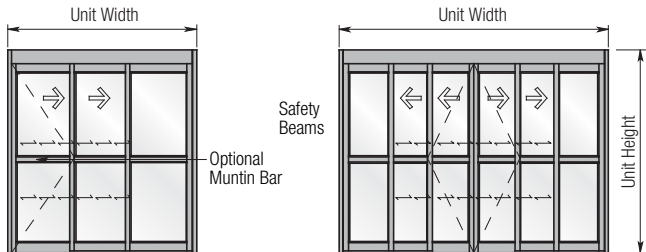

Shown: SX-X-0

**Type 110T**

Shown: O-X-SX-SX-X-0

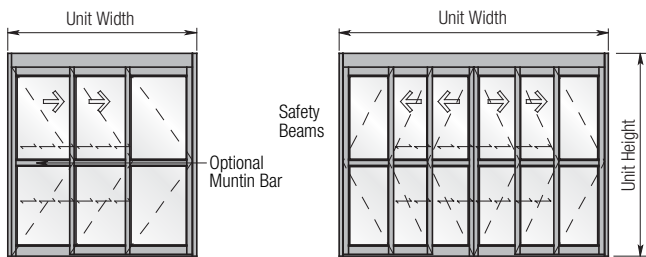

Shown: SX-SX-S0

**Type 310T**

Shown: S0-SX-SX-SX-SX-S0



## Elegant® Series 2001 All Glass System

### For Upscale Healthcare Facilities

The all-glass Elegant® system enhances your building's exterior beauty while offering all the advantages of automatic operation and energy efficiency. Supplied with 1/2" tempered glass.

- Frameless, offset glass design
- Heavy duty operator ensures quiet and smooth operation
- Available with up to 76" of clear opening width
- Available with panic bar

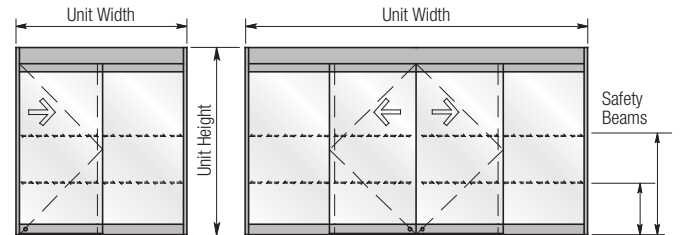

Shown: SX-0 (O-SX Opposite)

Shown: O-SX-SX-0

**Type 110**

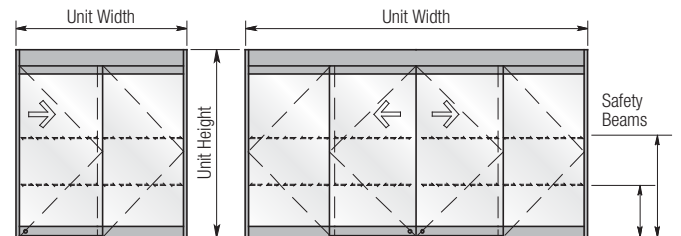

Shown: SX-S0 (S0-SX Opposite)

Shown: S0-SX-SX-S0

**Type 310**

### Selection Guide

Model	Type	Unit Width	Max. Clear Opening	Type 110 Breakout Opening	Type 310 Breakout Opening
<b>ProSlide® Telescoping</b>	Single	7' to 12' (2134–2743)	3' 7½" to 6' 11½" (1105–2121)	2' 1¼" to 3' 9¼" (641–1149)	6' 1" to 11' 1" (1854–3378)
	Bi-part	9' to 16' (2743–4877)	4' 1½" to 10' 1½" (1257–3086)	2' 7½" to 5' 7½" (800–1715)	7' 5" to 16' 5" (2261–5004)
<b>Elegant®</b>	Single	7' to 9' (2134–2743)	3' to 4' (914–1219)	3' 1¼" to 4' 1¼" (959–1264)	6' 3" to 8' 3" (1905–2515)
	Bi-part	9' to 14' (2743–4267)	3' 6" to 6' 4" (1067–1930)	3' 10" to 6' 4" (1168–1930)	7' 9½" to 12' 9½" (2375–3899)

# Automatic Entrance Systems Swinging & Folding



## Applications

- One-Way or Two-Way Traffic
- Entrances
- Corridors
- Fire Doors
- Patient Rooms
- Restroom Doors

## Options

Horton Automatics swing and folding door systems provide a full range of solutions for ADA-compliant handicap or high traffic automatic access.

- Single, pair or double egress door operation
- Available as surface applied operator or overhead concealed package complete with door and frame
- Available in folding door configurations



Series 4100 HD-Swing® heavy-duty operator with custom finish

## Header Operator Types

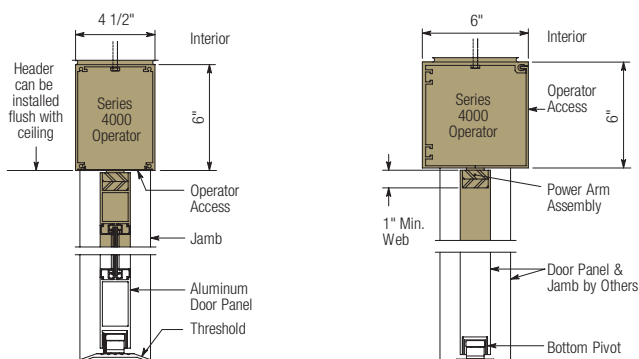

Series 4500 Bottom Access Direct Drive Overhead Concealed Packages

Series 4800 Side Access Direct Drive Overhead Concealed Packages

## Architectural Highlights

### Series 4000 and Series 7000 Operators

- Adjustable opening and closing speeds
- Adjustable time delay closing (2–30 seconds)
- Push-N-Go® activation for door opening assistance
- SoftTouch® reverses the door to the open position if it is stopped during closing
- Sensor reduces opening speed when obstruction is detected



## HD-Swing® Series 4100

### Full Power Heavy-Duty Operator

The Series 4000 operator is ideal for everyday use or use with large, heavy doors as well as high traffic areas.



- Choice of surface applied or overhead concealed installations
- Simple adjustments for low energy handicap or high traffic applications
- Single acting spring always returns door to a closed position with adjustable speed and force
- Compatible with all electrical or mechanical hardware
- Fire door swing operator available

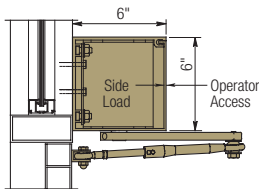

**Standard 6" x 6" Header**  
with Standard In-swing Arm Assembly

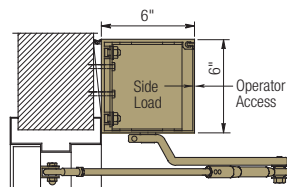
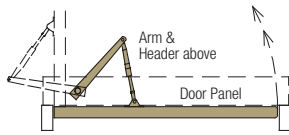

**Optional 6" x 6" Header**  
with Out-swing Arm Assembly

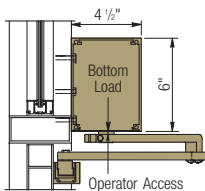
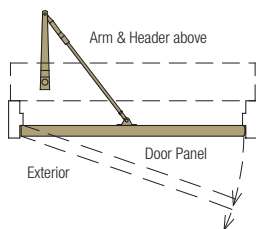

**Optional 4 1/2" x 6" Header**  
with Parallel In-swing Arm Assembly

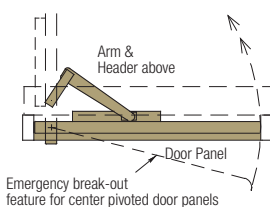

### Surface Applied Operator Configurations

See Selection Guide on page 22



## HD-Swing® LE Series 4100LE

### Industry Standard For Heavy-Duty, Low Energy Applications

#### Series 4000LE Low Energy ADA Compliant, Heavy Duty Operator

Available in our widest range of configurations, the Series 4000 operator is ideal for everyday use or use with large, heavy doors required to meet ADA and ANSI A117.1 and A156.19 as well as high traffic environments.



- Easy switching to full power (automatic) operation
- Choice of in-swing, out-swing, left or right-handed functions
- Surface applied or overhead concealed mounting
- Available in 4 1/2" x 6" bottom access or 6" x 6" side access header
- 1/8 HP drive for taller and heavier doors (optional)

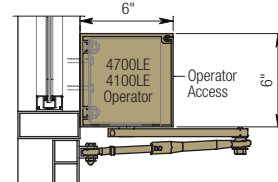

**Standard 6" x 6" Header**  
with Standard In-swing Arm Assembly

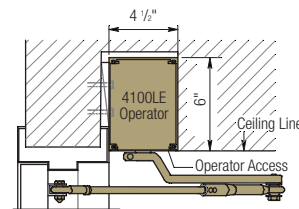
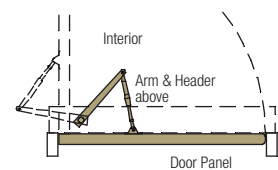

**Optional 4 1/2" x 6" Header**  
with Out-swing Arm Assembly

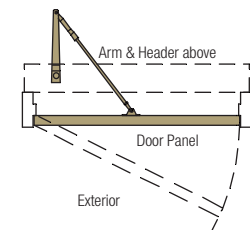

### Surface Applied Operator Configurations

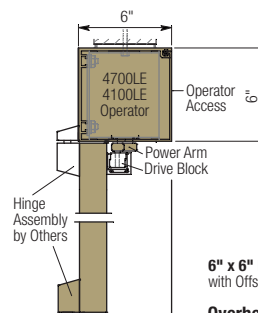

**6" x 6" Header**  
with Offset Arm Assembly

Overhead Concealed Side Access with Offset Arm Assembly

# Automatic Entrance Systems Swinging & Folding



## EasyAccess® Series 7100 Low Energy ADA Compliant Operator

The EasyAccess® operator is ideal for new or converted barrier-free openings per ANSI A117.1 and A156.19. Available as fire-rated operator EasyAccess® Series 7900.



- Automatic opening with knowing act activation
- Surface applied mounting
- Compatible with all electrical or mechanical hardware
- Fire door swing operator available

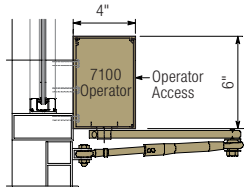

**Standard 4" x 6" Header**  
with Standard In-swing Arm Assembly

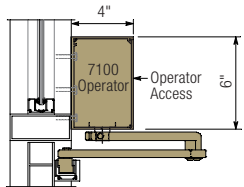
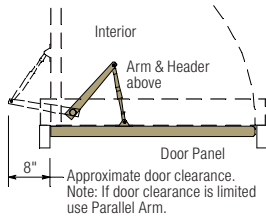

**Standard 4" x 6" Header**  
with Parallel In-swing Arm Assembly

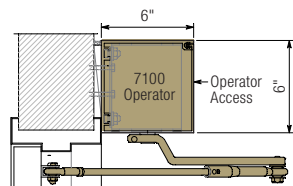
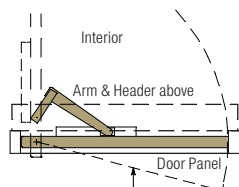

**Optional 6" x 6" Header**  
with Out-swing Arm Assembly

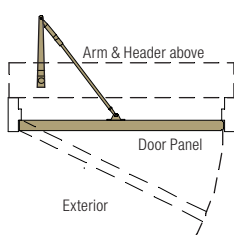

### Surface Applied Operator Configurations

Selection Guide							
Model	Type	Unit Width	Header Width	Max. Clear Opening	Max Breakout Opening		
<b>HD-Swing®</b> and <b>HD-Swing® LE</b>	Single	3' to 4' (914-1219)	3' 3" to 4' 3" (991-1295)	-	-		
	Pair	3' to 8' (914-2438)	6' 3" to 8' 3" (1905-2515)	-	-		
<b>EasyAccess®</b>	Single	3' to 3' 6" (914-1067)	3' 3" to 3' 9" (991-1143)	-	-		
	Pair	5' to 7' (1524-2134)	5' 3" to 7' 3" (1600-2210)	-	-		
<b>FoldingAccess®</b>	Single	3' 8" to 4' (1118-1219)	-	2' 8" to 3' (813-914)	2' 11" to 3' 3" (889-991)		
	Pair	6' to 10' (1829-3048)	-	4' 4" to 8' 4" (1321-2540)	4' 11" to 8' 11" (1499-2718)		



## FoldingAccess® Narrow Corridor Folding Door

Ideal for vestibules and corridors that require wide openings in a narrow hallway. The system may also be specified for manual operation. Available with magnetic lock and panic hardware.



- Emergency breakout
- Finger guards at all hinge points
- Accommodates 1- or 2-way traffic
- Available with manual operation for ICU applications
- Compatible with all electrical or mechanical hardware

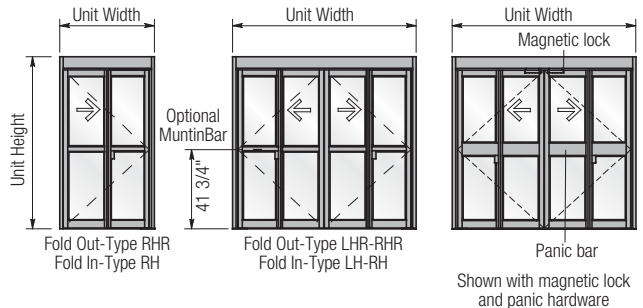



## Additional Swing Door Packages

### Custom Application Swing Closer

Package includes overhead concealed hydraulic closer with frame and center-pivoted doors. Doors are double-acting and can be right or left hand. This package is often used in multiple door installations where a manual swing door is located next to automatic sliding or revolving doors.

## Specialty Operators

### Super Duty Swing Door Operator

The opening and closing force provided by the Series 4700 surface applied operator is adjustable and delivers substantial torque at the output shaft. With its powerful motor, this operator can operate extremely heavy doors (up to 1500 lbs) such as hospital X-ray lead-lined or storage vault systems.

## Project Spotlight



### Project: Ann & Robert H. Lurie Children's Hospital of Chicago

*"At Lurie Children's, durability and reliability were of the utmost concern when selecting automatic doors for patient spaces in the ICUs and Emergency Department. Horton's proven track record of providing the highest quality automatic doors made them the perfect choice for such critical locations."*

Stuart Baur  
Principal / ZGF Architects LLP

# Automatic Entrance Systems Revolving



## Make a Grand Entrance

Increase energy savings by specifying a Horton Revolving Door. Horton Grand® and MiniGrand® revolving door systems are ideally suited to the traffic requirements of healthcare facilities. They offer impressive architectural appeal, generous openings and the extra advantage of a constant seal for energy efficiency and LEED credits.

## Architectural Highlights

- Easily customized with special finishes, metal cladding, roof panel designs, lighting, Segmented® or round wall design as well as extended canopies
- Smooth, quiet operation with emergency egress panels
- Constant seal reduces drafts and helps control energy costs

## Applications

- Main Entrances
- Emergency



To view our new revolving door video, use your smartphone to access the QR code.





## Grand® Series 9600 Large Diameter Vestibule System

This system provides spacious compartments for an elegant, energy efficient entrance. The Grand® system handles high traffic volumes including wheelchairs, walkers and stretchers.



- Segmented® or round drum design
- Customizable voice enunciator
- StormLock™\*\* feature for high wind and stack pressure conditions

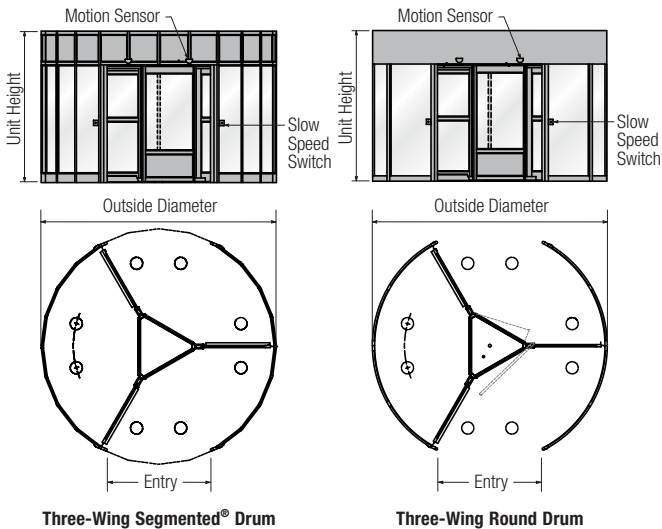

\*\*StormLock™ prevents doors from breaking out unless initiated by human intervention



## MiniGrand® Series 9300 Center Pivot Vestibule

The MiniGrand® offers the drum construction of a Grand® revolver with a compact design made possible by center pivot door wings.

- Segmented® or round drum design

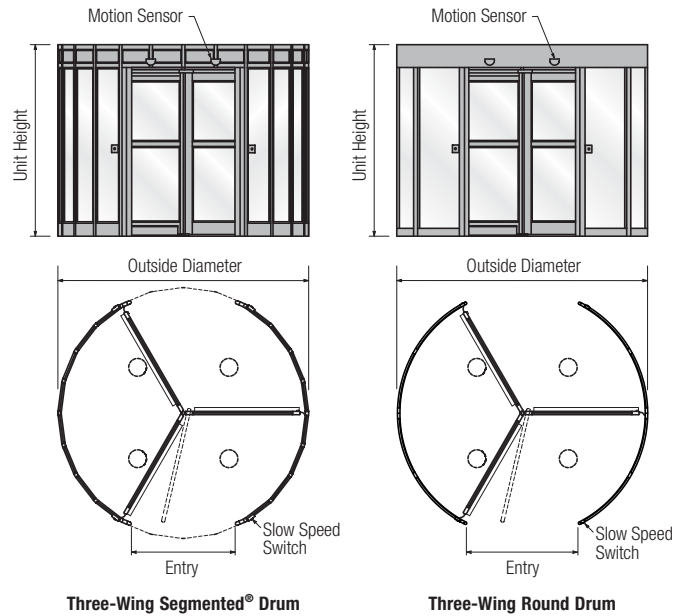

Manual revolving door systems are also available for alternate entrances that feature glass ceilings and elegant door panels to add drama along with function.

### Selection Guide

Model	Type	Outside Diameter	Segmented® Drum Throat Opening	Round Drum Throat Opening
Grand®	Three-Wing	12' (3658)	5' 3 ¼" (1619)	5' 1 ½" (1565)
	Three-Wing	14' (4267)	6' 3 ¼" (1924)	6' 1 ½" (1870)
	Three-Wing	16' (4877)	7' 3 ¼" (2229)	7' 1 ½" (2175)
MiniGrand®	Three-Wing	11' (3353)	4' 9 ¼" (1467)	4' 7 ½" (1413)
	Three-Wing	12' (3658)	5' 3 ¼" (1619)	5' 1 ½" (1565)

# Security Revolving Doors

## Control and Contain Unauthorized Entrance

Versatile, effective security solutions include bullet-resistant systems and early warning detection devices that restrict pedestrians with malicious intentions.

## Architectural Highlights

- Security level
- Bullet-resistant glass
- Anti-tailgating
- Anti-piggybacking





## ControlFlow® Automatic Security Door Systems

Available in a choice of 1- or 2-way card access, these systems have options for security including Level III bullet-resistant glass, Visdom HS® advanced 3D anti-piggybacking/anti-tailgating prevention sensors and overhead sensors in place of mats.



- Wireless programming options
- Customizable voice enunciator
- Magnetic breakaway for emergency egress

### 1-Way

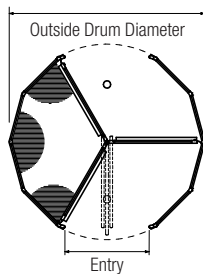

3-Wing Segmented® Drum

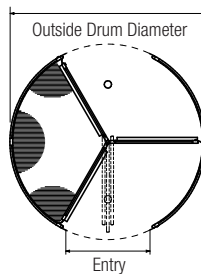

3-Wing Round Drum

### 2-Way Card Access

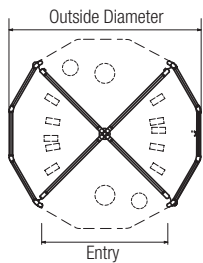

4-Wing Segmented® Drum

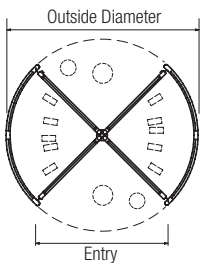

4-Wing Round Drum

## Project Spotlight



*“The Johns Hopkins Hospital project was a monumental project with the construction of two structures: an Adult and Childrens Tower. The magnitude and visibility of the project is unique, utilizing a wide variety of Horton Automatics products. This project was a combination of close coordination and cooperation with the owner, architect and general contractor, resulting in a successful project worthy of Johns Hopkins Hospital’s worldwide reputation.”*

Alan R. Funk, President  
Atlantic Door Control, Columbia, MD

Selection Guide					
Model	Type	Inside Diameter	Entry	Segmented® Drum Throat Opening	Round Drum Throat Opening
ControlFlow®	Three-Wing (1-way)	8' (2438)	3' 4 3/8" (1026)	8' (2438)	3' 6 7/8" (1089)
	Three-Wing (1-way)	9' (2743)	3' 10 3/8" (1178)	9' (2743)	4' 1/8" (1241)
	Three-Wing (1-way)	10' (3048)	4' 4 3/8" (1330)	10' (3048)	4' 6 7/8" (1394)
	Four-Wing (2-way)	6' (1829)	3' 10" (1168)	6' (1829)	3' 10 7/8" (1191)
	Four-Wing (2-way)	6' 6" (1981)	4' 2 3/8" (1280)	6' 6" (1981)	4' 3 1/8" (1299)
	Four-Wing (2-way)	7' (2134)	4' 6 3/4" (1391)	7' (2134)	4' 7 3/8" (1407)

# Special Purpose Doors & Windows



## Lead-Lined X-Ray Room Sliding Door Solutions

Horton lead-lined automatic slide doors for radiation and X-ray shielding applications are custom manufactured. These surface-mounted aluminum doors with a structural core are available with a Vision Life leaded glass option. Auto lock fail-safe functionality and a battery backup if power fails come standard.

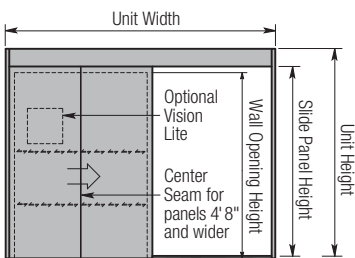

Shown: X-P (P-X Opposite)

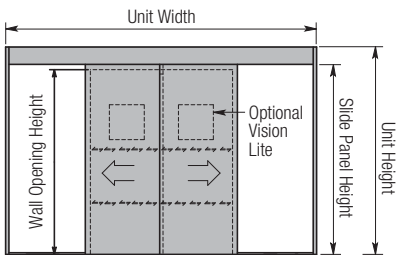

Shown: P-X-X-P



## Transaction Windows Automatic • Security • Manual

Specified for hospital drive-through pharmacies, labs, supply rooms and other secure interior areas, these windows can be equipped with transaction drawers, bullet-resistant glass, a choice of counter tops and other custom features.

- Fully assembled for easy installation
- Auto-close and reverse-on-contact functions
- Maximum security locks
- Manual or automatic packages

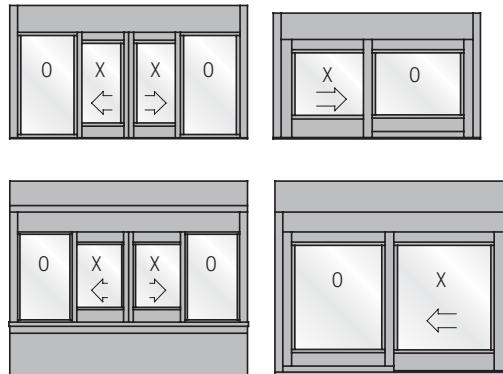

Selection Guide Model	Type	Unit Width	Max. Slide Opening
<b>Lead-Lined</b>	Single	7' 1 1/2" to 13' 1 1/2" (2171-4001)	3' to 6' (914-1829)
	Bi-parting	11' 5 1/2" to 15' 5 1/2" (3493-4712)	5' to 7' (1524-2134)
<b>Transaction Windows</b>	2 Panel (O-X or X-O) <i>With 1" insulated glass or 1/4" prep without glass. Also available with recessed pull.</i>	45 1/2" to 50" (1156-1270)	16" to 20 1/2" (406-521)
	2 Panel - Security (O-X/O-X or X-O/X-O) <i>With synchronized interlocking slide panels.</i>	50 1/4" (1276)	20 1/2" (521)
	4 Panel (O-X-X-O) <i>With thin stile panels, 1/4" tempered glass. Also available with 1/4" glass canopy, stainless steel counter and metal apron.</i>	53 1/2" (1359)	21" (533)



## Professional Installation and Service



Horton brings you the professional support of factory-authorized distributors. All Horton systems are built to exceed applicable quality and safety standards including:

- ANSI standards for pedestrian doors
- 1990 ADA requirements for barrier-free entrances
- Tested to UL 1784 to meet National Fire Protection Association (NFPA) regulations on select products
- National building codes related to emergency exit
- American Testing Laboratory ratings for wind load and forced entry on select products
- CSA, IBC, Miami-Dade, BOCA and other regional requirements on select products
- Listed by Intertek (ETL) for compliance to UL 325 Electrical Door, Drapery, Gate, Louver and Window Operators and Systems

Call your Horton distributor today for design, specification and application assistance.

Visit [www.hortondoors.com](http://www.hortondoors.com) to find a distributor near you.

**Specify Horton and demand AAADM certified installation.**

**AAADM** American Association of  
Automatic Door Manufacturers

# Activation and Sensors

## Sensors for Swinging Doors and Folding Doors

Sensor packages include systems with varying degrees of detection. Basic systems incorporate a microwave or active infrared sensor on the approach side with presence sensors and infrared photo beams on the swing side. Enhanced systems add door-mounted presence sensors to each side of the swinging door. Guide rails are normally specified on the swing side (or fold side of the folding doors) per ANSI A156.10. Two rails are required if a wall or barrier is not present.

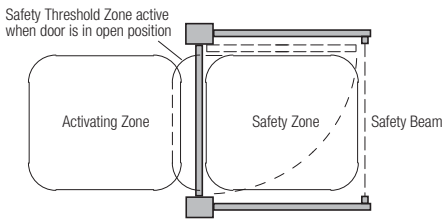

Swinging Doors

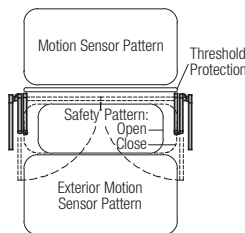

Bi-folding Doors



Selection Guide			
Model	Part Number	Description	Type
<b>Fully Automatic Vista Sensor System (ANSI 156.10)</b>	C1884 or C1234	Choice of Microwave Motion Sensor OR Active Infrared Motion/Presence Sensor	Activation
	C1829	Active Infrared Sensor	Safety
	C7783	Photo Beam (Wall or Guide Rail Mounted)	Safety
	C1878-2	Door Mounted Presence Sensor (Each Side of Door)	Safety
<b>Knowing Act Low Energy Activation and Safety Options (ANSI 156.19)</b>	C1829	Infrared Presence Detection	Optional Safety
	C7783	Safety Beam Set	Optional Safety
	C1260-5*	4 1/2" x 4 1/2" Stainless Steel Switch	Optional Activation
	C1260-5RC*	4 1/2" x 4 1/2" Wireless Stainless Steel Switch	Optional Activation

\*Both with international handicap logo

## Sensors for Sliding Doors

All dual systems utilize infrared reflective or microwave sensing on both sides for two-way traffic activation. In addition, Horton includes photo beam sensors mounted in the sidelite or frame at 24" and 48" from the floor to prevent closure when a pedestrian is in the opening.

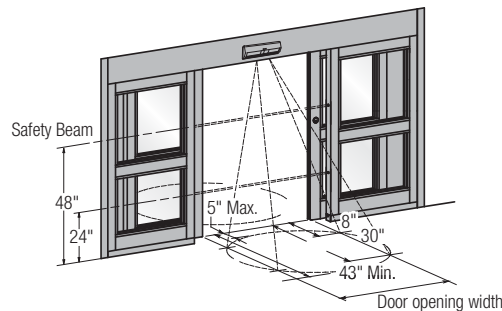

Selection Guide			
Model	Part Number	Description	Type
<b>Sensors</b>	C1827**	Microwave Motion/Active Infrared Presence	Optional – Activation/Safety
	C1238**	Active Infrared Motion/Presence	Optional – Activation/Safety
	C7775	Dual Transmitter/Receiver Photo Beams	Redundant Safety

\*\*A standard sliding door system features a pair of either of these sensors

## Activating Switches

- Round or square metal push plates
- Push-button
- Keyless digital-code entry
- Key switch
- Electric mat
- Touchless photoelectric wall switch
- Explosion-proof solid state switch
- Touchless sensors
- Fingerprint, retina, face ID

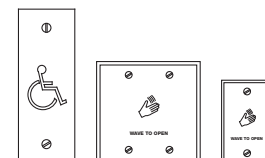
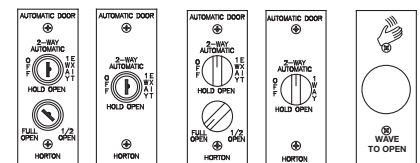
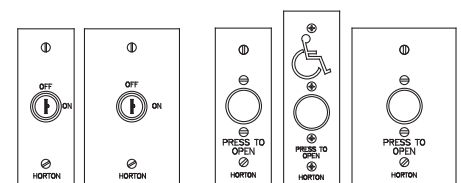



COMPARE

## Door Comparison Chart

Review Horton door features at a glance in this handy chart . . . . . [page 8](#)

---



BROWSE

## Interactive Product Selection Guide

Quickly navigate through Horton products, specifications and application information using this easy interactive tool.  
<https://www.hortondoors.com/assets/files/HortonInteractiveProductSelectionGuide.pdf>

---



CHOOSE

## DoorGenius™

Quickly receive a general idea of the type of door you need for a project using this simple online tool.  
<https://www.hortondoors.com/>

---



SPECIFY

## SpecGenius™

Find the exact door you need, automatically generate a spec, find detailed product information, customization options, save and organize projects on this user-friendly interface.  
<https://genius.hortondoors.com/>

---



CONNECT

## Spec Desk

Get in touch with our in-house spec consultants at  
1.800.531.3111 or [specs@hortondoors.com](mailto:specs@hortondoors.com)

Sidra Medical and Research Center  
Doha, Qatar



**Horton Pedestrian Access Solutions**

- Horton Automatics®
- FLEX™ by Horton
- Door Services Corporation®
- Won-Door®

**Horton Automatics**

World Headquarters  
4242 Baldwin Boulevard  
Corpus Christi, Texas 78405-3399 USA  
Phone: 800-531-3111, 361-888-5591  
Fax: 361-888-6510

[www.hortondoors.com](http://www.hortondoors.com)

**Overhead Door Corporation**

A Sanwa Holdings Company